



VCU

Virginia Commonwealth University
VCU Scholars Compass

Theses and Dissertations

Graduate School

2009

THE SMALL MOLECULE BCL-2 INHIBITOR HA14-1 POTENTIATES THE LETHALITY OF A REGIMEN COMBINING MEK1/2 AND CHK1 INHIBITORS IN MULTIPLE MYELOMA CELLS

Leena Youssefian
Virginia Commonwealth University

Follow this and additional works at: <https://scholarscompass.vcu.edu/etd>



Part of the [Biochemistry, Biophysics, and Structural Biology Commons](#)

© The Author

Downloaded from

<https://scholarscompass.vcu.edu/etd/1799>

This Thesis is brought to you for free and open access by the Graduate School at VCU Scholars Compass. It has been accepted for inclusion in Theses and Dissertations by an authorized administrator of VCU Scholars Compass. For more information, please contact libcompass@vcu.edu.

**THE SMALL MOLECULE BCL-2 INHIBITOR HA14-1 POTENTIATES THE
LETHALITY OF A REGIMEN COMBINING MEK1/2 AND CHK1 INHIBITORS
IN MULTIPLE MYELOMA CELLS**

A Thesis submitted in partial fulfillment of the requirements for the degree of Masters of
Science at Virginia Commonwealth University.

by

LEENA EILEEN YOUSSEFIAN

Bachelor of Science in Biological Sciences, University of California at Irvine, 2006

Director:

STEVEN GRANT, M.D.

PROFESSOR

DEPARTMENT OF MEDICINE, BIOCHEMISTRY, AND PHARMACOLOGY

Virginia Commonwealth University
Richmond, Virginia
May 2009

Acknowledgments

I owe sincere gratitude to the following people:

My family, Hasmik, Vigen, Vimik, and Cody Youssefian for their continuous moral support and understanding during the most hectic times of my life.

My friends/colleagues: Albert Petrossian, Mona Shalwala, Lora Kramer, Dmitry Lembersky, Ankita Patel, and Sanjay Amin for providing me with motivational support, good music and comedy relief during exceedingly stressful times.

Dr. Xin-Yan Pei, Dr. Yun Dai, and Dr. Shuang Chen for their enlightening words, contributions, and energy-producing snacks during times of confusion, curiosity, and low blood glucose levels.

My Graduate Committee Members: Dr. Dent and Dr. Gewirtz for their help and informational input.

Finally, I would like to thank Dr. Steven Grant for his guidance and for providing me with this excellent research opportunity.

TABLE OF CONTENTS

Acknowledgements.....	ii
Abstract.....	v
Section 1 INTRODUCTION.....	1
1.1 Cell Survival vs. Apoptosis.....	1
1.2 Growth and Proliferation of Multiple Myeloma Cells.....	2
1.3 The Importance of Bim.....	5
1.4 The Strategy Combining MEK1/2 and Chk1 Inhibitors: A Potential Therapy for Multiple Myeloma	5
1.5 Applications of HA14-1 in Bcl-2 Over-expression in MM Cells.....	7
1.6 Objectives.....	8
Section 2 MATERIALS AND METHODS.....	8
2.1 Cells and Reagents.....	8
2.2 Plasmids and Transfection.....	9
2.3 Experimental Format.....	9
2.4 Mitochondrial Membrane Potential ($\Delta\Psi_m$) Assay.....	10
2.5 Assessment of Cell Death.....	10
2.6 Western Blot Analysis.....	10
2.7 Statistical Analysis.....	11
Section 3 RESULTS.....	11
3.1 Ectopic Over-expression of Bcl-2 in MM Cells Blocks Cell Death Induced by MEK1/2 and Chk1 Inhibitors.....	11
3.2 Co-administration of HA14-1 with a Regimen Combining MEK1/2 and Chk1 Inhibitors Promotes Cell Death in MM Cells.....	14

3.3 Co-administration of HA14-1 Overcomes Bcl-2-mediated Protection from Cell Death Induced by the MEK1/2/Chk1 Inhibitor Regimen in MM Cells...	16
3.4 HA14-1 Enhances Activation of the Caspase Cascade Triggered by the PD184352/CEP3891 Regimen in MM Cells.....	18
3.5 HA14-1 Re-sensitizes Bcl-2 Over-expressing MM cells to Activation of the Caspase Cascade Induced by the Regimen Combining MEK1/2 and Chk1 Inhibitors.....	20
3.6 Co-treatment with MEK1/2 and Chk1 Inhibitors Blocks ERK-mediated Bim _{EL} Phosphorylation and Degradation in MM cells, while these Events are not Affected by HA-14-1.....	21
3.7 HA14-1 Fails to Modify ERK Inactivation and Bim _{EL} Accumulation Mediated by the CEP3891/PD184352 Regimen in Bcl-2 Over-expressing MM Cells...	23
Section 4 DISCUSSION.....	24
References.....	31
Vita.....	34

Abstract

THE SMALL MOLECULE BCL-2 INHIBITOR HA14-1 POTENTIATES THE LETHALITY OF A REGIMEN COMBINING MEK1/2 AND CHK1 INHIBITORS IN MULTIPLE MYELOMA CELLS

by Leena E. Youssefian, B.S.

A thesis submitted in partial fulfillment of the requirements for the degree of Masters of Science at Virginia Commonwealth University.

Virginia Commonwealth University, 2009

Director: Dr. Steven Grant, M.D.
Professor, Department of Medicine, Biochemistry, and Pharmacology

Previously, we have found that the co-administration of MEK1/2 inhibitors and Chk1 inhibitors synergistically induce multiple myeloma cell apoptosis through upregulation of the BH3-only pro-apoptotic protein Bim. However, these apoptotic events were largely blocked by the characteristic over-expression of Bcl-2 or Bcl-xL in multiple myeloma cells. HA14-1, a small molecule Bcl-2 inhibitor, may therefore circumvent this resistance to apoptosis by blocking Bcl-2 and Bcl-xL anti-apoptotic protein actions. In our project, we hypothesize that the co-administration of HA14-1 with MEK/Chk1 inhibitors will enhance apoptosis in multiple myeloma (MM) cells. To test this hypothesis, we exposed MM cells U266 and RPMI8226, or those cells with Bcl-2 over-expressing stable clones to minimally toxic concentrations of MEK1/2 inhibitor (PD184352) with Chk1 inhibitor (CEP3891) for 24 hours, followed by the Bcl-2 inhibitor (HA14-1). To date, our data indicates that co-administration of HA14-1 with the PD184352/CEP3891 regimen significantly enhances apoptotic death in U266/Bcl-2

multiple myeloma cells compared with the PD184352/CEP3891 regimen. Future studies are designed to elucidate mechanisms underlying Bcl-2 and Bcl-xL anti-apoptotic protein interactions with the Bak and Bim apoptotic proteins, focusing release of Bak and Bim from Bcl-2/Bcl-xL, and subsequent Bax/Bak activation.

INTRODUCTION

1.1 Cell Survival vs. Apoptosis

Normal cells have the propensity to either live or die. Depending upon cellular conditions, there are three known mechanisms leading to cell death: apoptosis, necrosis, and autophagy. Cells may also be abrogated in various stages of the cell cycle, such as G₀, thereby maintaining a quiescent, non-proliferative state.¹

Apoptosis is a process of programmed cell death which occurs during the course of normal development and maintenance of the mammalian anatomy. It is characterized by typical morphological and biochemical hallmarks including, cell shrinkage, DNA fragmentation, chromatin condensation, and plasma membrane blebbing.^{1,2,3} Activation of caspase proteins is the major characteristic of apoptosis. Caspases can be activated through two distinct routes: an extrinsic pathway, involving death receptors, or an, intrinsic pathway which involves the mitochondria.⁴ The extrinsic pathway, or the death receptor pathway, induces apoptosis through stimulation of death receptors of the TNF (tumor necrosis factor) receptor superfamily, such as CD95 (APO-1/Fas) or TRAIL (TNF-related apoptosis inducing ligand) receptors. These receptors are activated by CD95-L (CD95 ligand) and TRAIL, respectively. The activated receptors result in receptor aggregation and recruitment of FADD (Fas-associated death domain), an adaptor molecule, and caspase-8. Upon recruitment, caspase-8 becomes activated and initiates apoptosis by direct cleavage of downstream effector caspases.^{2,3} The determination of a cell to survive or undergo apoptotic death through the intrinsic pathway is regulated by the Bcl-2 (B-cell CLL/lymphoma2) family proteins.⁵

1.2 Growth and Proliferation of Multiple Myeloma Cells

Multiple myeloma (MM) is a generally incurable plasma cell disorder originating in the bone marrow. It arises from the dysregulated proliferation and survival of differentiated plasma cells. As shown in Figure 1, growth and survival of MM cells relies on IL-6 (interleukin-6) and IGF-1 (insulin-like growth factor-I), which promote up-regulation of anti-apoptotic proteins.⁶ As a consequence, these cells exhibit high levels of the anti-apoptotic Bcl-2 family proteins, particularly Bcl-2, Bcl-xL, and Mcl-1.

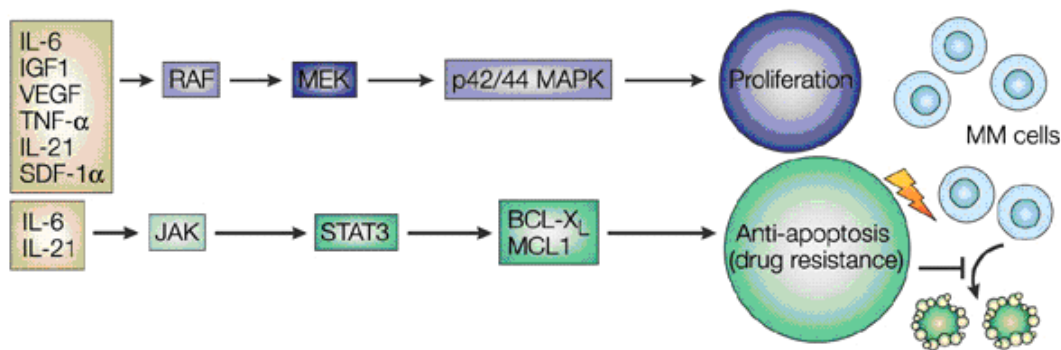

2002, Anderson KC (Revised)

Figure 1. Growth and proliferation of multiple myeloma cells relies on the interactions of the extracellular IL-6 and IGF-1 signals with the cell surface protein receptors on MM cells. These interactions elicit cascade signals in the Raf/MEK and JAK/STAT pathways, which promote up-regulation of anti-apoptotic proteins Bcl-2, Bcl-xL, and Mcl-1 to generate resistance to apoptosis.

The Bcl-2 family proteins play a key role in regulation of the intrinsic pathway of apoptosis through Mitochondrial Outer Membrane Permeabilization (MOMP). Normal cells display a delicate balance between pro-apoptotic and anti-apoptotic Bcl-2 family proteins. The pro-apoptotic proteins such as Bax, Bak, and Bim promote the deadly fate of a cell while the anti-apoptotic proteins such as Bcl-2, Bcl-xL, Mcl-1 and Bcl-w,

function to keep the cell alive.⁴ The functionality of these proteins is determined by their BH (Bcl-2 homology) domains (Figure 2).

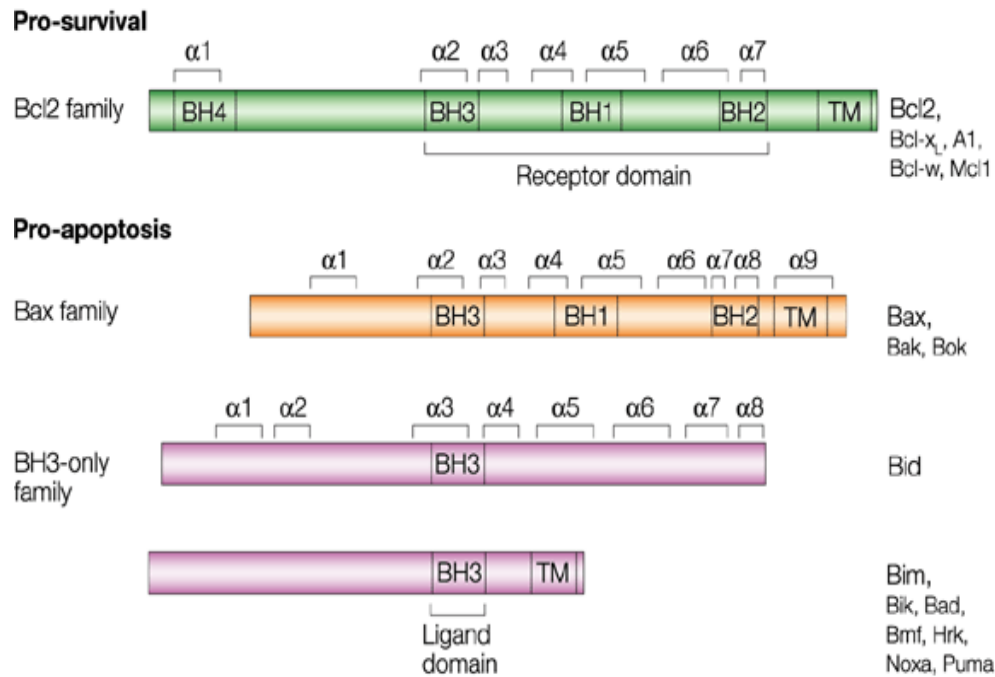

Nature Reviews | Cancer

Figure 2. The Bcl-2 family of proteins is comprised of anti-apoptotic and pro-apoptotic proteins. The anti-apoptotic proteins (e.g., Bcl-2, Bcl-xL, and Mcl-1) have BH (Bcl-2 homology) domains 1-4. There are two classes of pro-apoptotic proteins; one class (including Bax and Bak) has BH domains 1-3 and the other (designated BH3-only proteins, e.g., Bim) has only the BH3 domain.⁴

Mechanistically, during stress or cellular damage, BH3-only proteins become activated. Certain BH3-only proteins, such as Bim, activate the pro-apoptotic Bcl-2 family proteins Bax (Bcl-2-associated-X protein) or Bak (Bcl-2-agonist killer).⁴ Activated Bax and Bak proteins homo-oligomerize and form a pore in the outer mitochondrial membrane. This pore allows for the escape of the pro-apoptotic molecule cytochrome c. The escape of cytochrome c is the major initiator of the intrinsic pathway

of apoptosis.⁷ Cytochrome c activates caspase-9 which in turn activates caspase-3 leading to cleavage of key cellular proteins downstream, such as the DNA repair protein PARP (Poly ADP-ribose polymerase). These events are the underlying mechanisms that are known to promote apoptosis (Figure 3).^{4,8}

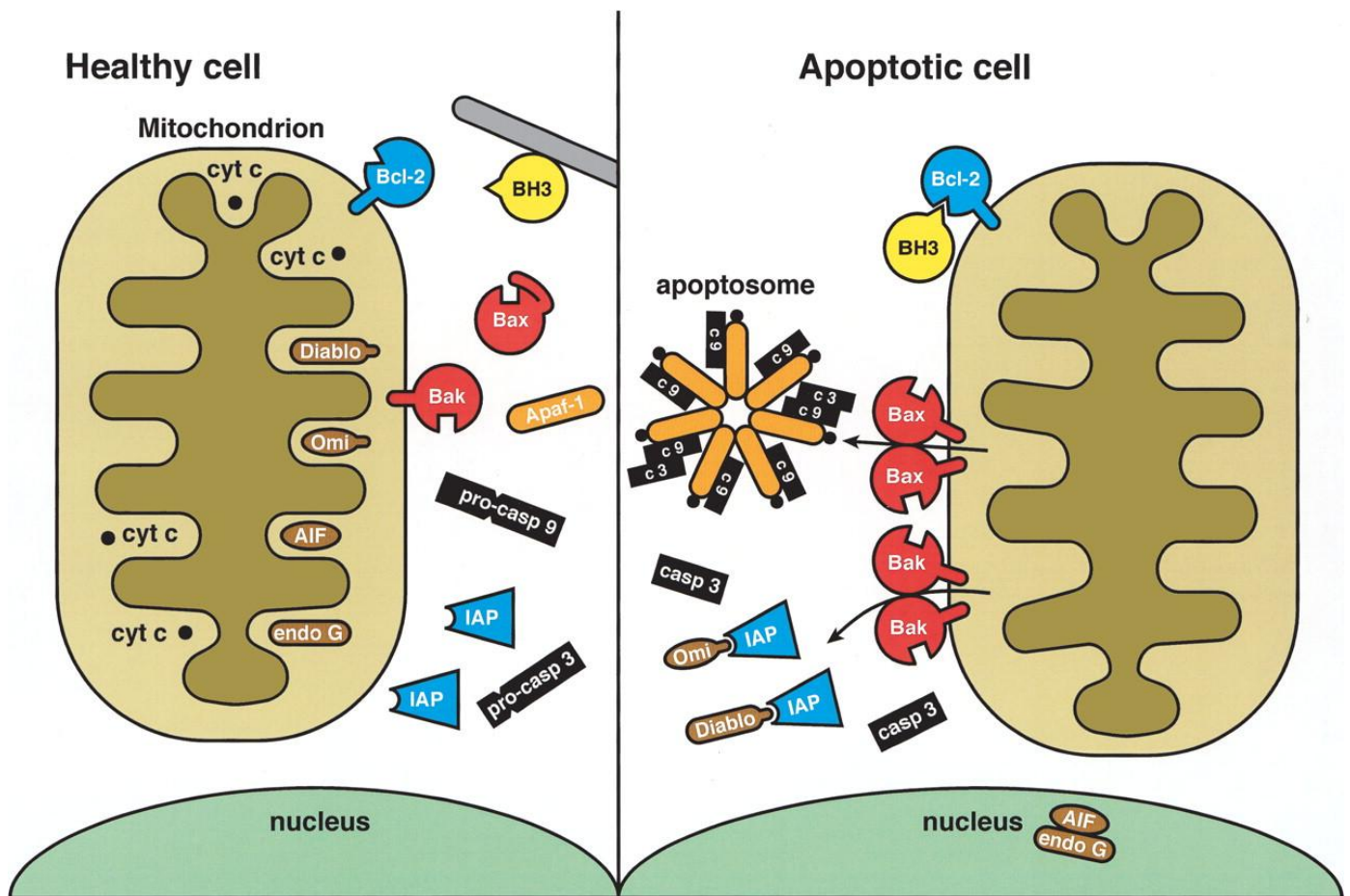

Figure 3. In a healthy cell, the anti-apoptotic protein Bcl-2 is localized on the surface of the mitochondrial outer membrane. It interferes with Bax/Bak homo-oligomerization and thereby prevents apoptosis mediated by the mitochondria-dependent intrinsic pathway. In an apoptotic cell, Bcl-2 is bound by BH3-only proteins. As a consequence, Bax and Bak are unleashed from the sequestration of Bcl-2. Bax/Bak then homo-oligomerize to form a pore for the release of cytochrome c that subsequently forms an apoptosome in which caspase-9 is activated.

1.3 The Importance of Bim

Growth factor deprivation, noxious stimuli, and chemotherapeutic agents such as, glucocorticoids, Gleevec, and paclitaxel induce cell death through the activation of the intrinsic pathway of apoptosis. These agents activate Bim, a BH3-only apoptotic protein critical for the initiation of apoptosis. Bim is widely expressed in multiple tissues including hematopoietic stem cells. As a product of alternative splicing, Bim exists as at least 3 isoforms: Bim_{EL}, Bim_L, and Bim_S.⁹ The function and expression of Bim is regulated at two levels: transcriptionally and post-translationally.¹⁰ The most abundant isoform of Bim is Bim_{EL}.^{11,12} In viable cells, Bim_{EL} is known to be localized on the mitochondrial outer membrane and is believed to be bound to anti-apoptotic proteins Bcl-2, Bcl-xL, and Mcl-1.¹³ These anti-apoptotic proteins sequester Bim_{EL} and keep it in its inactive form. Furthermore, post-translational regulation of Bim_{EL} is primarily mediated by ERK1/2 (extracellular signal-regulated kinase).¹¹ Multiple phosphorylations of Bim_{EL} by ERK1/2 initiates ubiquitination and proteosomal degradation of Bim_{EL}.^{14,15}

1.4 The Strategy Combining MEK1/2 and Chk1 Inhibitors: A Potential Therapy for Multiple Myeloma

Since Bim_{EL} plays a major role in apoptosis, previously, our group has investigated the role of Bim_{EL} in synergistic interactions mediating apoptosis between agents targeting checkpoint kinase 1 (Chk1, eg., UCN-01) and mitogen-activated protein kinase kinase 1/2 (MEK1/2, e.g., PD184352) respectively.⁸

UCN-01 (7-hydroxystaurosporine) is a derivative of the kinase inhibitor staurosporine. Although, it was originally developed as protein kinase C inhibitor, it has

subsequently been shown to inhibit the activity of Chk1 as well as other kinases.^{16,17,18} At nanomolar concentrations, UCN-01 induces apoptosis in malignant hematopoietic cells.¹⁹

Previously, our group reported that exposure of human leukemia and myeloma cells to UCN-01 at subtoxic concentrations, induces phosphorylation and marked activation of MEK1/2 and ERK1/2. This event was significantly blocked by the MEK1/2 inhibitor PD184352. Furthermore, co-administration of PD184352 highly synergistically potentiated apoptosis induced by UCN-01. However, the mechanism by which ERK1/2 inactivation enhances apoptosis in this situation has not been fully defined.^{8,20,21} Further studies regarding the implications of the enhancement of apoptosis in MM cells with this regimen have led us to discover that perturbations in Bim_{EL} phosphorylation play a significant functional role in this process.⁸

The interaction between MEK1/2 inhibitors and Chk1 inhibitors to synergistically induce multiple myeloma cell apoptosis may also involve down-regulation and/or inhibition of anti-apoptotic proteins.⁸ As mentioned earlier, one of the characteristics of multiple myeloma cells is that they rely on IL-6 and IGF1 for survival. As a consequence, they exhibit a high expression of the Bcl-2, Bcl-xL, and Mcl-1 anti-apoptotic proteins.¹³ The high expression of these anti-apoptotic proteins in cells accounts for one of the major mechanisms by which these cells display resistance to the conventional treatments for hematological malignancies.²² These anti-apoptotic Bcl-2 family proteins act to prevent MOMP and the release of cytochrome c from the mitochondria by sequestering Bax /Bak homo-oligomerization to form a pore on the mitochondrial outer membrane.²³ Since the combination regimen of PD184352/UCN-01 induces apoptosis primarily via the mitochondria-dependent intrinsic pathway, this event is largely blocked by the ectopic

over-expression of Bcl-2 or Bcl-xL in MM cells.^{24,25} Such findings raise a possibility that the combination therapy of MEK1/2 inhibitors and Chk1 inhibitors may not efficiently kill tumor cells bearing those high levels of Bcl-2. In other words, interruption of Bcl-2 function may be required for the restoration of tumor cell sensitivity to the MEK1/2/Chk1 inhibitor regimen, particularly in the cells harboring over-expression of Bcl-2.

1.5 Applications of HA14-1 in Bcl-2 Over-expression in MM Cells

The small-molecule inhibitor HA14-1 functions as a Bad mimetic. It has the capacity to bind to the Bcl-2 surface pocket and disrupt its association with apoptotic proteins such as Bax or Bak.²⁶ Previously our group has shown that HA14-1, in combination with the CDK inhibitor flavopiridol, effectively triggers oxidative injury, mitochondrial dysfunction, caspase activation, and apoptosis in multiple myeloma cells (including those resistant to conventional therapeutic agents such as dexamethasone, melphalan, and doxorubicin).²⁴

HA14-1, as a small molecule Bcl-2 inhibitor, may circumvent the Bcl-2 mediated resistance of MM cells to apoptosis induced by the Chk1/MEK1/2 inhibitor regimen. Theoretically, HA14-1 may act to block anti-apoptotic protein actions of Bcl-2 and Bcl-xL which represent a major roadblock to the Chk1/MEK1/2 inhibitor strategy. In this project, we are attempting to test whether HA14-1 in conjunction with the MEK1/2 inhibitor PD184352 and the novel, highly selective Chk1 inhibitor CEP3891 is able to promote apoptosis in MM cells that ectopically over-express Bcl-2. CEP3891, as a highly selective Chk1 inhibitor, is currently under preclinical evaluation, which has been found

to potentiate the lethal effects of DNA-damaging agents by abrogating both G2-M and G1 checkpoints.^{27,28}

1.6 Objectives

A. PD184352 and CEP3891 will synergistically induce apoptosis in MM cells, which will be prevented by ectopic over-expression of Bcl-2.

B. Co-administration of HA14-1 with a regimen combining MEK1/2 and Chk1 inhibitors will promote apoptosis in MM cells by circumventing the cytoprotective effects of Bcl-2 over-expression.

C. The underlying mechanism involving this phenomenon may be related to Bim_{EL} up-regulation and simultaneous disabling of both Mcl-1 and Bcl-2, which leads to unleashing and activation of Bax and Bak, thereby triggering MOMP and apoptosis.

MATERIALS AND METHODS

2.1 Cells and Reagents

The human MM cell lines U266 and NCI-H929 were purchased from ATCC (Rockville, MD) and maintained as described earlier.²¹ RPMI8226 cells were kindly provided by Dr. Alan Lichtenstein (UCLA, LA), and cultured as reported previously.²⁶ All experiments were performed using logarithmically growing cells (4×10^5 to 6×10^5 ml).

The selective MEK inhibitor PD184352 was purchased from Upstate Biotechnology (Lake Placid, NY). The specific Chk1 inhibitor CEP3891 was provided by Cephalon, Inc.

and used at a concentration of 400-500 nM/L. Cell-permeable, low-molecular-weight Bcl-2 inhibitor HA14-1 was purchased from Biomol (Plymouth Meeting, PA, USA). Reagents were dissolved in sterile DMSO and stored frozen under light protection at -20°C. In all experiments, final concentrations of DMSO did not exceed 0.1%.

2.2 Plasmids and Transfection

cDNAs encoding mouse (Upstate Biotechnology) and human full-length Bcl-2 were cloned into pUSE vectors. Transfections were performed using an Amaxa Nucleofector device and Cell Line Specific Nucleofector Kits (Amaxa, Cologne, Germany) per the manufacturer's instructions: Kit V/program G-015 for RPMI8226 and Kit C/program X-005 for U266. For stable transfections, cells were continuously cultured under selection with G418 (750 µg/ml for RPMI8226, or 400 µg/ml for U266).

2.3 Experimental Format

All experiments were performed utilizing logarithmically growing cells ($4-6 \times 10^5$ cells/ml). Cell suspensions were placed in sterile FALCON tissue culture dishes (Becton Dickinson, Franklin Lakes, NJ, USA) for 24h, and then incubated with PD184352 and CEP-3891 for 24 h at 37 °C. At the end of this period, HA14-1 was added to the suspension, and the dishes placed in a 37 °C, 5% CO₂ incubator for various intervals. After drug treatment, cells were harvested and subjected to further analysis as described below.

2.4 Mitochondrial Membrane Potential ($\Delta\Psi_m$) Assay

After drug treatment, cells (2×10^5) were incubated with 40 nM/L 3,3-dihexyloxacarbocyanine (DiOC₆, Molecular Probes Inc., Eugene, OR, USA) in PBS at 37°C for 20 minutes and then analyzed by flow cytometry. The percentage of cells exhibiting low level of DiOC₆ uptake, which reflects loss of mitochondrial membrane potential, was determined using Becton-Dickinson FACScan (Becton-Dickinson, San Jose, CA, USA).

2.5 Assessment of Cell Death

After drug treatment, cell death was assessed by 7-AAD staining (0.5 µg/ml 7-AAD at 37°C for 30 minutes) and flow cytometry analysis.

2.6 Western Blot Analysis

Western blot samples were prepared from whole-cell pellets using Triton X-100 buffer as described previously.²⁶ Amount of total protein was quantified using Coomassie Protein Assay Reagent (Pierce, Rockford, IL). Equal amounts of protein (20 µg per condition) were separated on precast sodium dodecyl sulfate-polyacrylamide gel electrophoresis (SDS-PAGE) gels (Invitrogen, Carlsbad, CA) and electro-transferred onto nitrocellulose membranes. For detection of phosphorylated proteins, no SDS was included in the transfer buffer, and Tris-buffered saline (TBS) was used throughout. Blots were probed with primary antibodies as follows. Blots were re-probed with anti-actin (Sigma) or anti-tubulin antibody (Oncogene, San Diego, CA) to ensure equal loading and transfer of proteins. Primary antibodies included anti-phospho-p44/42 (Thr202/Tyr204)

MAPK (ERK1/2) and anti-p44/42 MAPK (Cell Signaling, Beverly, MA), poly(ADPribose) polymerase (PARP) antibody (Biomol), anti-caspase-3 (BD Transduction Laboratories), anti-cleaved caspase-3 (17 kDa) (Cell Signaling), anti-caspase-9 (BD PharMingen), anti-cleaved caspase-9 (35 kDa) (Cell Signaling), anti-Bim_{EL} (Calbiochem), anti-mouse Bcl-2 (CHEMICON International, Inc., CA), and anti-human Bcl-2 oncoprotein (DAKO, Carpinteria, CA).

2.7 Statistical Analysis

For flow cytometric analyses of DiOC6 and 7-AAD, values represent the means (\pm SD) for at least 3 separate experiments performed in triplicate experiments. The significance of differences between experimental variables was determined using the Student t-test.

RESULTS

3.1 Ectopic Over-expression of Bcl-2 in MM Cells Blocks Cell Death Induced by MEK1/2 and Chk1 Inhibitors

To test whether Bcl-2 over-expression blocks apoptosis when co-exposed to minimally toxic concentrations of the Chk1 and MEK1/2 inhibitors (CEP3891/PD184352), we employed U266 cells that ectopically over-express mouse Bcl-2 in comparison with their parental cells. We observed a dramatic increase in cell death of U266 cells when exposed (48 hours) to minimally toxic doses of a combination of the novel Chk1 inhibitor, CEP3891 (400 nM) with PD184352 (5 μ M) (Figure 4A). The

same regimen administered in Bcl-2 over-expressing U266 cells showed significantly reduced mitochondrial membrane potential loss in comparison to the parental cells ($P < 0.001$) (Figure 4B). Consistent with previous results,^{8,20} these results indicate that co-administration of the Chk1 inhibitor CEP3891 with PD184352 synergistically induces apoptosis in U266 cells, while over-expression of Bcl-2 largely blocks these apoptotic events. Therefore, the anti-apoptotic protein Bcl-2 functions to block mitochondrial damage and cell death induced by the CEP3891/PD184352 regimen.

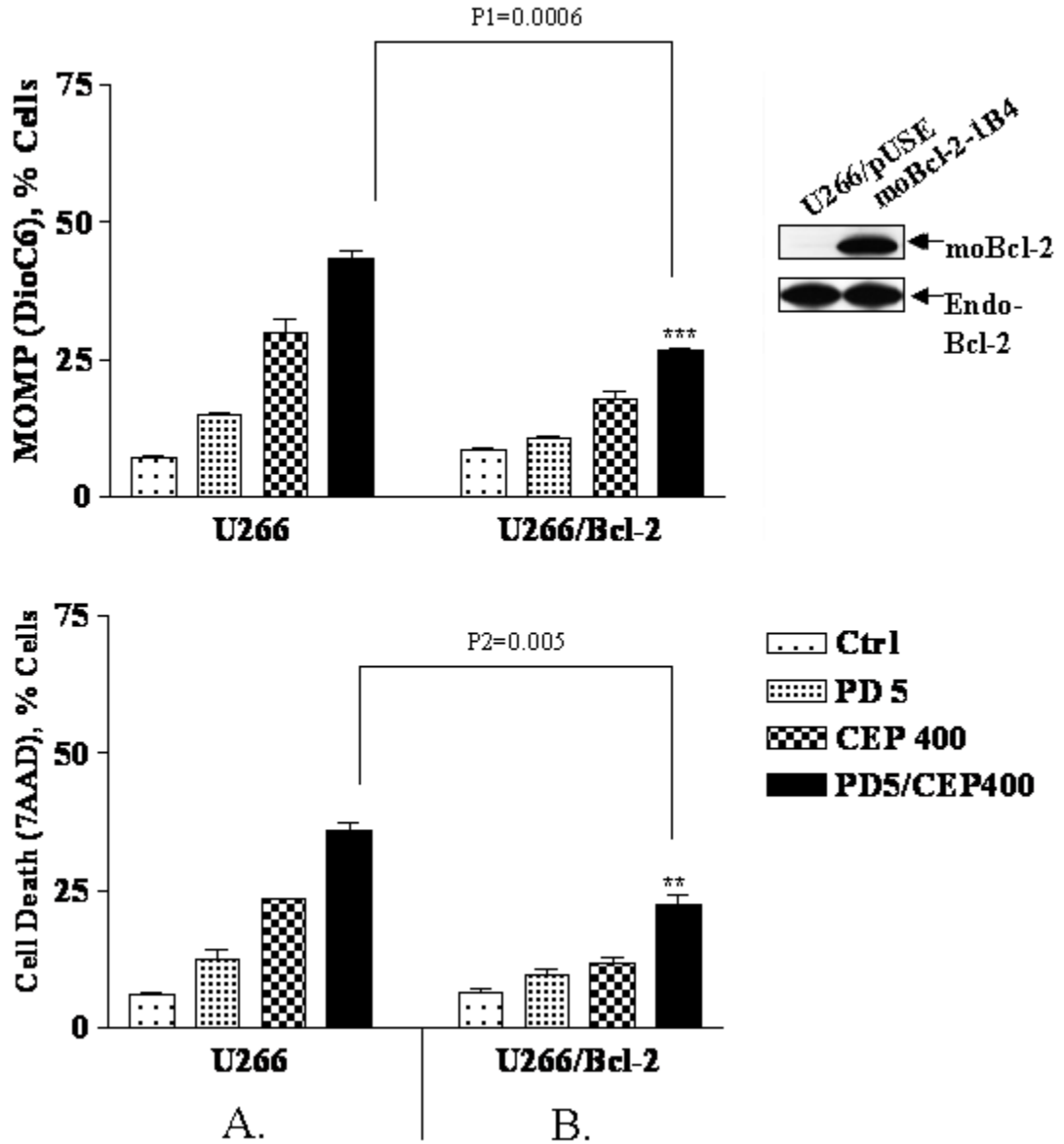

Figure 4. Ectopic over-expression of Bcl-2 in these multiple myeloma cells blocks cell death and events of MOMP induced by MEK1/2 and Chk1 inhibitors. Panel A shows the percentage of parental U266 cells undergoing mitochondrial outer membrane permeabilization (MOMP) (top left) and Cell Death (bottom left) under four different conditions. Panel B shows the percentage of Bcl-2 over-expressing U266 cells undergoing mitochondrial outer membrane permeabilization (MOMP) (top right) and Cell Death (bottom right) under the same four conditions. All cells were incubated with the MEK1/2 inhibitor, PD184352, and the Chk1 inhibitor, CEP3891, for 48 hours before results were analyzed. The Bcl-2 over-expressed cells display a lower incidence of MOMP and cell death under each condition compared to the parental U266 cells.

3.2 Co-administration of HA14-1 with a Regimen Combining MEK1/2 and Chk1 Inhibitors Promotes Cell Death in MM Cells

To test whether HA14-1 antagonizes Bcl-2 to further enhance cell death induced by the CEP3981/PD184352 regimen, we exposed parental U266 cells to sub-toxic concentrations of the CEP3891/PD184352 regimen for 24 hours, followed by co-administration of HA14-1 (2.5 μ M; 24 hours). Treatment of the U266 cells with the CEP3891/PD184352/HA14-1 combination resulted in a greater promotion of apoptosis compared to the CEP3891/PD184352 regimen (Figure 5A). These results were further confirmed in two other myeloma cell lines: RPMI8226, CEP3891 (500 nM)/ PD184352 (2.5 μ M) / HA14-1 (1 μ M) and H929 (500 nM)/ PD184352 (2.5 μ M) / HA14-1 (2.5 μ M) (Figure 5B,C).

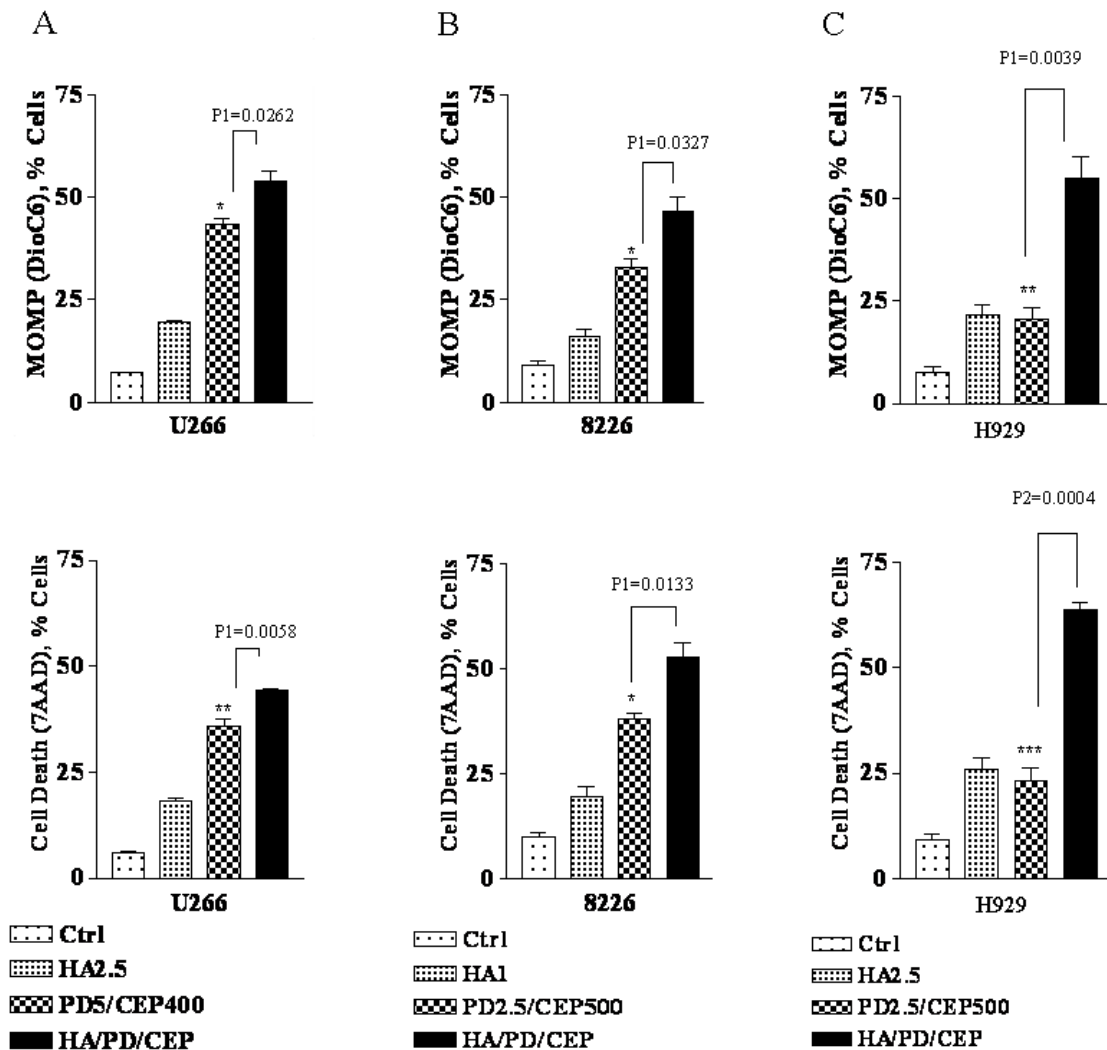

Figure 5. HA14-1 enhances lethality of the PD184352/CEP3891 regimen in MM cells. Panel A shows the percentage of parental U266 cells undergoing mitochondrial outer membrane permeabilization (MOMP) (top left) and Cell Death (bottom left) under four different conditions. Panel B shows the percentage of 8226 cells undergoing mitochondrial outer membrane permeabilization (MOMP) (top center) and Cell Death (bottom center) when treated with the same three drugs. Panel C shows the percentage of H929 cells undergoing mitochondrial outer membrane permeabilization (MOMP) (top right) and Cell Death (bottom right) under when treated with the same three drugs as the U266 and H929 cells. All cells were incubated with the MEK1/2 inhibitor PD184352 and the Chk1 inhibitor CEP3891 for 24 hours followed by the Bcl-2 inhibitor HA14-1 for 24 hours before results were analyzed. In all three MM cell lines, co-administration of HA14-1 with the MEK1/2 and Chk1 inhibitors results in a higher degree of cell death in MM cells.

3.3 Co-administration of HA14-1 Overcomes Bcl-2-mediated Protection from Cell Death Induced by the MEK1/2/Chk1 Inhibitor Regimen in MM Cells

To test whether HA14-1 antagonizes Bcl-2 to overcome its anti-apoptotic function against the CEP3981/PD184352 regimen in Bcl-2 over-expressing cells, we exposed the Bcl-2 over-expressing U266 cells to minimally toxic concentrations of the CEP3891/PD184352 regimen with HA14-1 (2.5 μ M; 48 hours). Treatment of the Bcl-2 over-expressing U266 cells with the CEP3891/PD184352/HA14-1 combination resulted in a significantly greater cell death compared to the CEP3891/PD184352 regimen ($P < 0.01$) (Figure 6). We further confirmed these results in ectopic human Bcl-2 over-expressing RPMI8226 cells, which were treated with CEP3891 (500 nM)/PD184352 (2.5 μ M) /HA14-1 (1 μ M) ($P < 0.01$) (Figure 7).

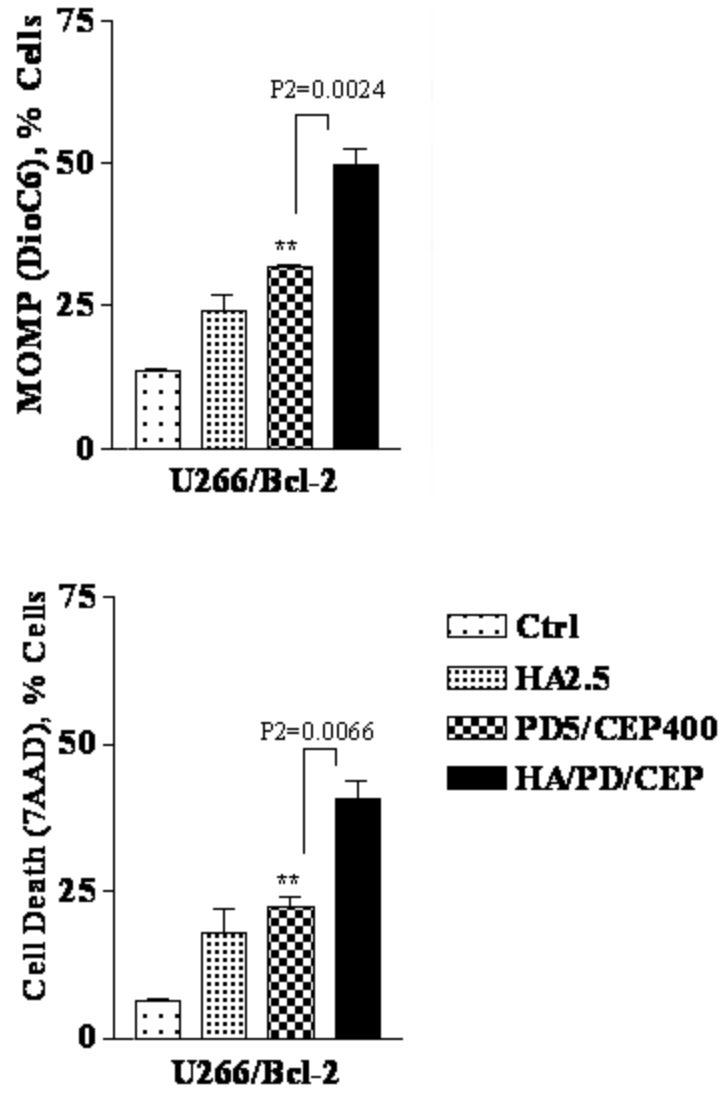

Figure 6. HA14-1 restores sensitivity of the Bcl-2 over-expressing U266 cells to the MEK1/2/Chk1 inhibitor regimen.

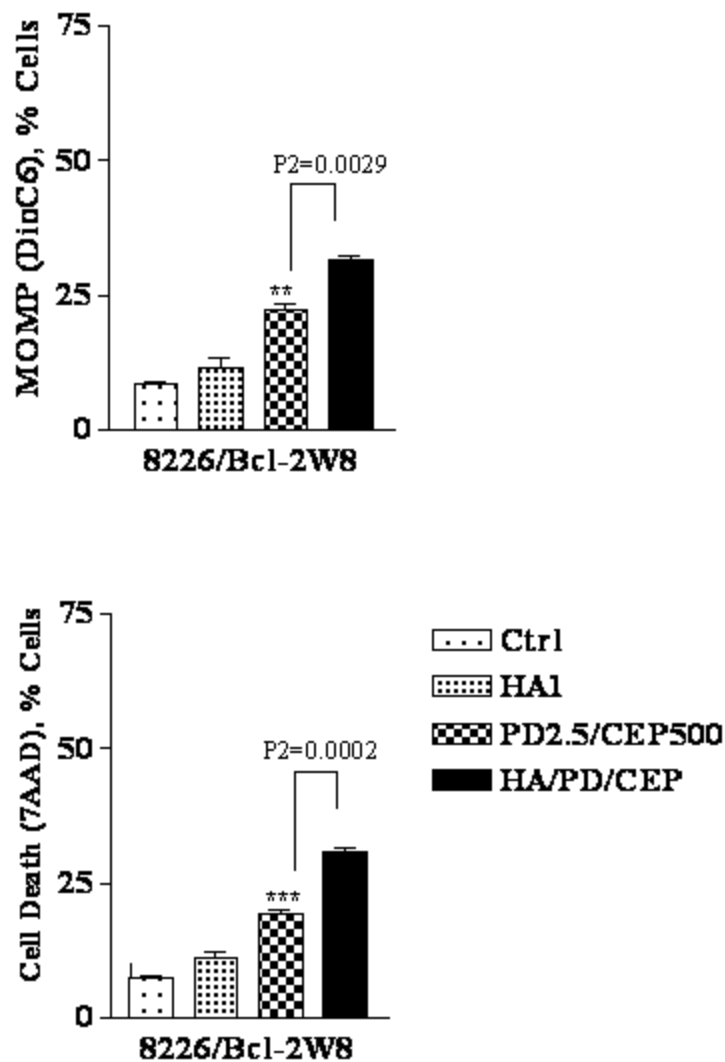

Figure 7. HA14-1 significantly increases mitochondrial damage and cell death in RPMI8226 cells ectopically over-expressing human Bcl-2.

3.4 HA14-1 Enhances Activation of the Caspase Cascade Triggered by the PD184352/CEP3891 Regimen in MM Cells

We next examined the molecular events which are associated with potentiation of PD184352/CEP3891 lethality by HA14-1. To this end, Western blot analysis was performed to compare effects of the CEP3891/PD184352 regimen in the absence and

presence of HA-14-1 regarding activation of caspase-9 and caspase-3, as well as resulting PARP cleavage in both U266 and H929 MM cells.

In U266 cells, exposure to PD187352 and CEP3891 markedly induced cleavage of caspase-9, caspase-3, and PARP, while co-administration of HA14-1 further lead to a modest, but clear, increase in these events (Figure 8). A similar phenomenon was observed in the H929 MM cell line (Figure 9).

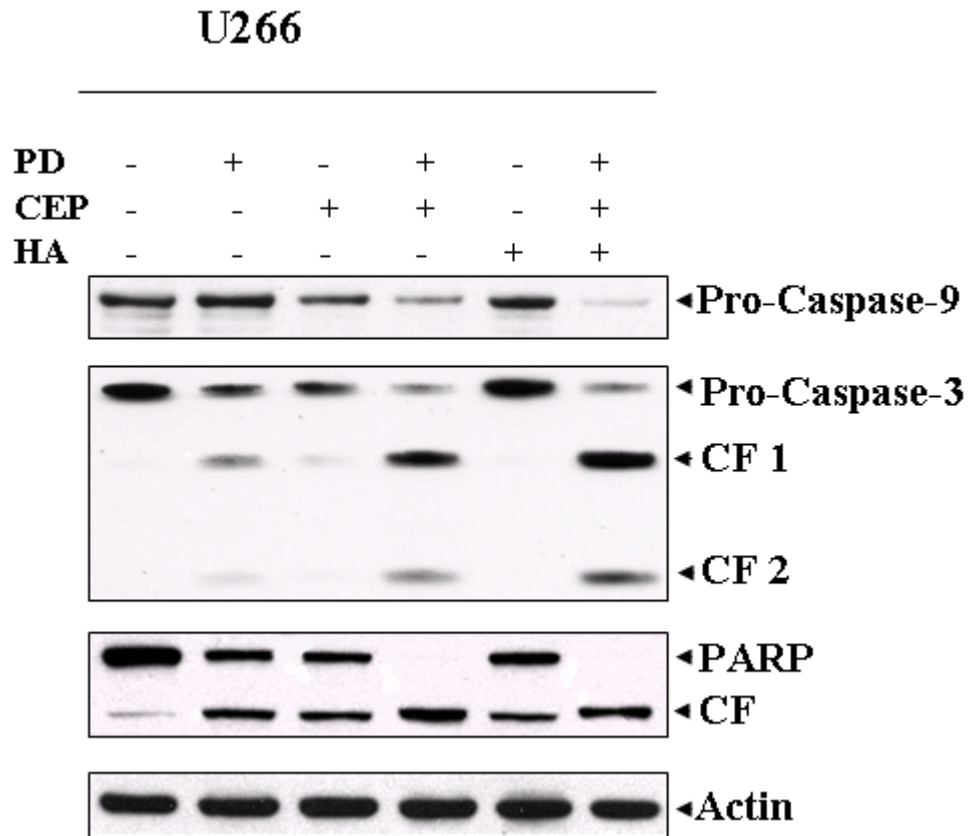

Figure 8. HA14-1 modestly increases activation/cleavage of caspase-9, caspase-3 and PARP cleavage in U266 cells exposed to the PD184352/CEP3891 regimen.

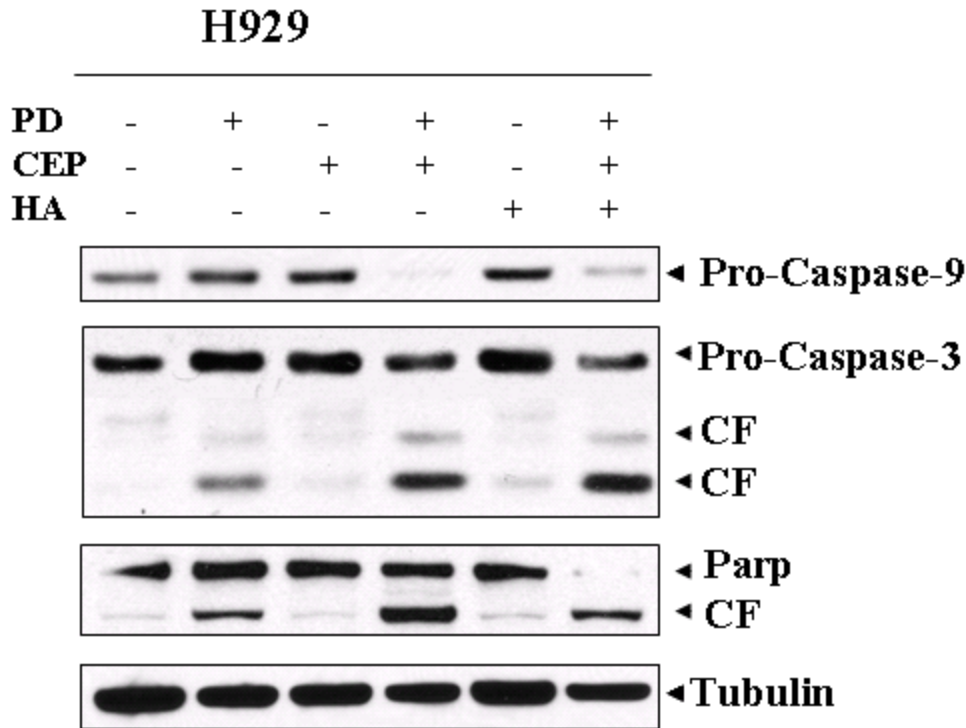

Figure 9. HA14-1 slightly enhances cleavage of caspase-9, caspase-3 and PARP in H929 cells treated with PD184352/CEP3891.

3.5 HA14-1 Re-sensitizes Bcl-2 Over-expressing MM cells to Activation of the Caspase Cascade Induced by the Regimen Combining MEK1/2 and Chk1 Inhibitors

We then tested whether the ability of Bcl-2 over-expressing MM cells overcoming resistance to the CEP3891/PD184352 regimen with HA14-1 is associated with restoration of the capacity of this regimen to activate apoptotic signaling. In this context, it was observed that co-administration of HA14-1 with CEP3891/PD184352 markedly enhanced cleavage/activation of caspases 9 and 3 and degradation of PARP when compared to the PD184352/CEP3891 regimen (Figure 10). These findings indicate that ectopic expression of Bcl-2 generates a protective mechanism against activation of the caspase cascade triggered by the MEK1/2/Chk1 inhibitor regimen, while HA14-1, by

binding to and disabling function of over-expressed Bcl-2, restores sensitivity of these cells to such a regimen.

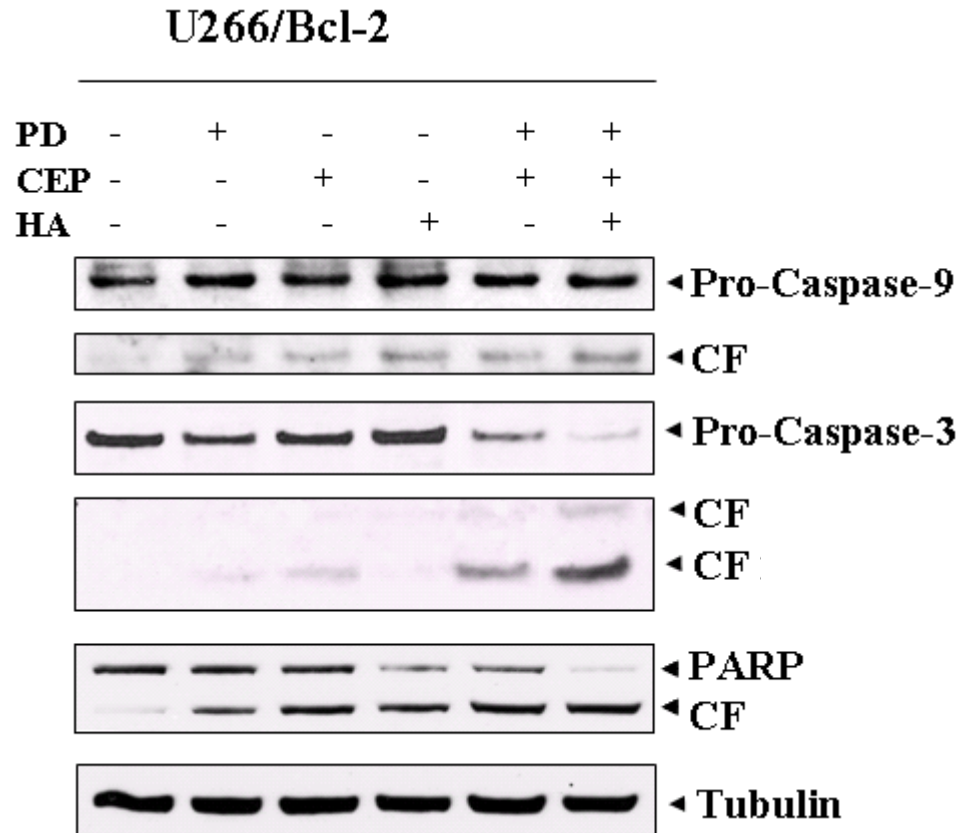

Figure 10. The capacity of the PD184352/CEP3891 regimen to induce activation of caspase cascade can be restored by HA14-1 in Bcl-2 over-expressing MM cells.

3.6 Co-treatment with MEK1/2 and Chk1 Inhibitors Blocks ERK-mediated Bim_{EL} Phosphorylation and Degradation in MM cells, while these Events are not Affected by HA-14-1

Our group previously reported that exposure of MM cells to the Chk1 inhibitor UCN-01 results in a marked increase in phosphorylation of ERK1/2, which is blocked by the co-administration of the MEK1/2 inhibitor PD184352. We have also demonstrated that UCN-01 treatment induces phosphorylation and degradation of Bim_{EL} and that co-administration of PD184352 dramatically blocks phosphorylation and down-regulation of

Bim_{EL} induced by UCN-01. Furthermore, knockdown of Bim_{EL} by shRNA diminishes lethality of PD184352/UCN-01 in MM cells, indicating a critical functional role of Bim_{EL} in apoptosis induced by this regimen.^{8,20}

In this study, we observed that exposure of U266 cells to the novel, more selective Chk1 inhibitor CEP3891 (400 nM, 48 hours) also resulted in marked increase in phosphorylation of ERK1/2 and phosphorylation/degradation of Bim_{EL}. These events were largely blocked by the co-administration of 5 μM PD184352 (Figure 11). However, there is no significant difference in changes of ERK phosphorylation and Bim_{EL} expression mediated by the CEP3891/PD184352 regimen in either absence or presence of HA14-1, while HA14-1 treatment alone resulted in a modest decrease in Bim_{EL} level (Figure 11).

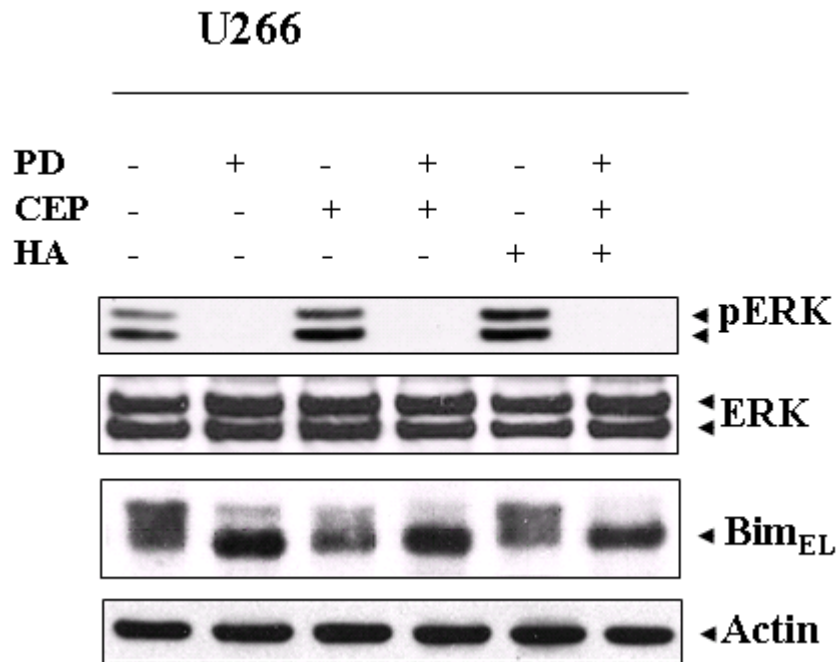

Figure 11. PD184352 prevents ERK-mediated Bim_{EL} phosphorylation and degradation induced by CEP3891, an event not affected by co-administration of HA14-1 in U266 cells.

Similar events in ERK1/2 and Bim_{EL} phosphorylation/degradation were observed in another MM cell line H929 when exposed to the CEP3891/PD184352 regimen with or without HA14-1 (Figure 12).

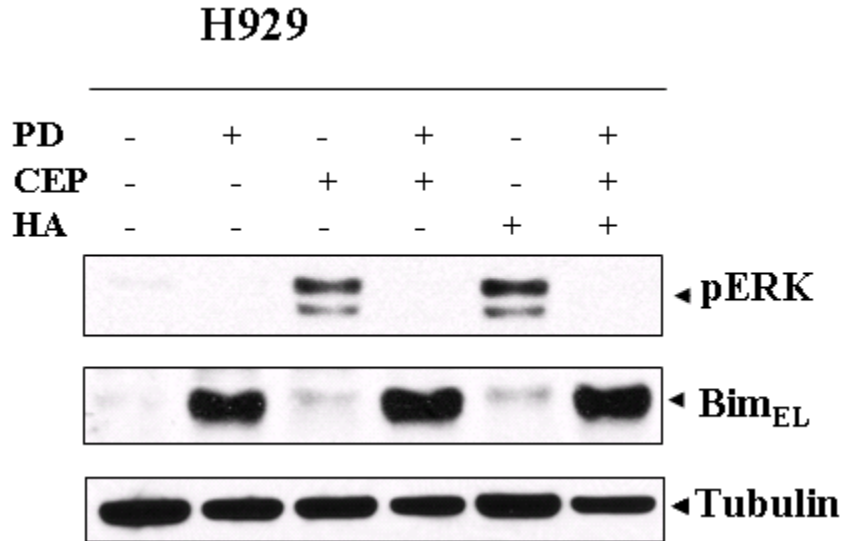

Figure 12. Co-administration of HA14-1 does not interfere with changes in ERK phosphorylation and Bim_{EL} expression in H929 cells exposed to PD184352/CEP3891.

3.7 HA14-1 Fails to Modify ERK Inactivation and Bim_{EL} Accumulation Mediated by the CEP3891/PD184352 Regimen in Bcl-2 Over-expressing MM Cells

Since HA14-1 was able to restore sensitivity of Bcl-2 over-expressing MM cells to the PD184352/CEP3891 regimen, we further tested whether this Bcl-2 antagonist will affect ERK phosphorylation statues and Bim_{EL} levels in this setting. Bcl-2 over-expressing U266 cells displayed similar patterns as noted in the parental U266 cells, in which PD184352 almost completely blocked ERK1/2 phosphorylation in response to CEP3891, accompanied by Bim_{EL} accumulation, while there is no notable influence by co-administration of HA-14-1 (Figure 13). Similar results were found in the Bcl-2 over-expressing RPMI8226 cells (data not shown). Together, these results suggest that HA14-1 may act to interrupt Bcl-2 function (e.g., binding of Bim_{EL}), rather than to modify

expression of Bim_{EL}, a BH3-only protein that plays a critical role in mediation of apoptotic signaling induced by the MEK1/2/Chk1 inhibitor strategy.

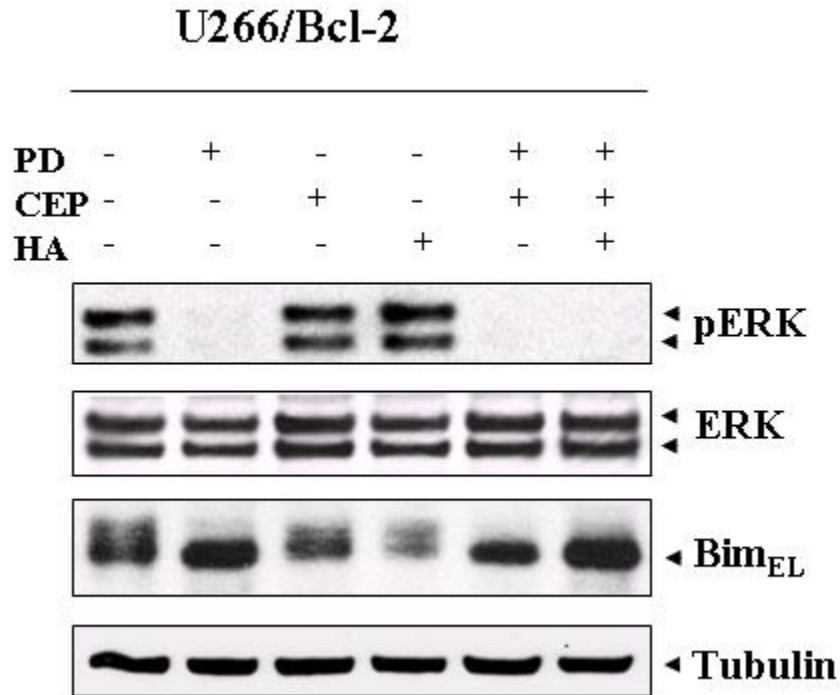

Figure 13. HA14-1 does not change the patterns of ERK phosphorylation and Bim_{EL} expression in the ectopic Bcl-2 over-expressing U266 cells.

DISCUSSION

Previous work from our group has shown that the MEK1/2 inhibitor, PD184352, blocks Chk1 inhibitors (e.g., UCN-01) induced phosphorylation/activation of MEK1/2/ERK1/2 in multiple myeloma cells, leading to a dramatic increase in apoptosis. This lethal interaction could be largely blocked by ectopic over-expression of either Bcl-2 or Bcl-xL.^{8,29} The Bcl-2 oncoprotein is commonly over-expressed in hematological malignancies including multiple myeloma, providing a cell with protection from apoptosis induced by various therapies. Thus, in order to further develop this new

therapeutic strategy, it is important to define functional roles of Bcl-2 and to investigate an additional approach to ensure the efficacy of this strategy in myeloma cells with over-expression of Bcl-2. Post-translational regulation of the pro-apoptotic protein Bim_{EL} is primarily mediated by MEK1/2/ERK1/2 signals.¹¹ Activated ERK1/2 can mediate multiple phosphorylations of Bim_{EL}, leading to its ubiquitination and proteosomal degradation.^{14,15} We have also demonstrated that exposure of MM cells to UCN-01 induces ERK activation-associated Bim_{EL} phosphorylation and degradation, while these events are blocked by PD184352, resulting in marked Bim_{EL} accumulation. Moreover, prevention of Bim_{EL} expression by shRNA significantly diminishes apoptotic signaling cascade triggered by the PD184352/UCN-01 regimen. Therefore, potentiation of Chk1 inhibitor lethality by MEK1/2 inhibitors seems to involve loss of balance between anti- and pro-apoptotic Bcl-2 family proteins.

In the present studies, we employed CEP3891, a novel and highly selective Chk1 inhibitor under preclinical evaluation, in place of UCN-01, which exhibits multiple actions excluding inhibition of Chk1. Notably, exposure of MM cells to CEP3891 induces phosphorylation/activation of ERK1/2, while co-administration with the MEK1/2 inhibitor PD184352 blocks ERK1/2 activation and induces apoptosis in several human myeloma cell lines. These results are consistent with those found in the case of UCN-01. We also found that ectopic over-expression of Bcl-2 significantly blocks apoptosis induced by the newer MEK1/2/Chk1 inhibitor (i.e., PD184352/CEP3891) regimen.

In order to investigate the functional roles of Bcl-2, and overcome the resistance mediated by Bcl-2 in the Bcl-2 over-expressing cells, we tested a strategy that targets and inhibits the function of Bcl-2 by using the Bcl-2 antagonist HA14-1. HA14-1 is a small

molecule inhibitor, designed as a Bcl-2 ligand based on the three dimensional structure of the Bcl-2 protein.²⁹ HA14-1 inhibits function of Bcl-2 by binding to the surface pocket of Bcl-2, thereby disrupting its binding with Bax/Bak and free the latter to trigger MOMP and apoptosis. Previous reports have demonstrated that HA14-1 blocks the function of the anti-apoptotic Bcl-2 family proteins, thereby activating caspase-9 and caspase-3 to induce apoptosis in tumor cells.

In the present work, we investigated the function of Bcl-2 by co-administering HA14-1 with the PD184352/CEP3891 regimen both in parental MM cells and in their counterparts that ectopically over-express Bcl-2. In doing so, we monitored three endpoints: 1) Mitochondrial outer membrane permeabilization. 2) Extent of apoptosis. 3) ERK-mediated Bim_{EL} phosphorylation/activation as well as total abundance. The results, by comparing Bcl-2 over-expressing MM cells with their parental cells, indicate that co-administration of HA14-1 further increases apoptosis synergistically induced by PD184352 and CEP3891 in MM cell lines. More importantly, ectopic over-expression of Bcl-2 in U266 or RPMI8226 myeloma cells markedly blunt lethality of the PD184352/CEP3891 regimen, while co-treatment with HA14-1 is able to overcome over-expressing Bcl-2 mediated resistance toward the PD184352/CEP3891 regimen. The following is a proposed mechanistic model for our study (Figure 14).

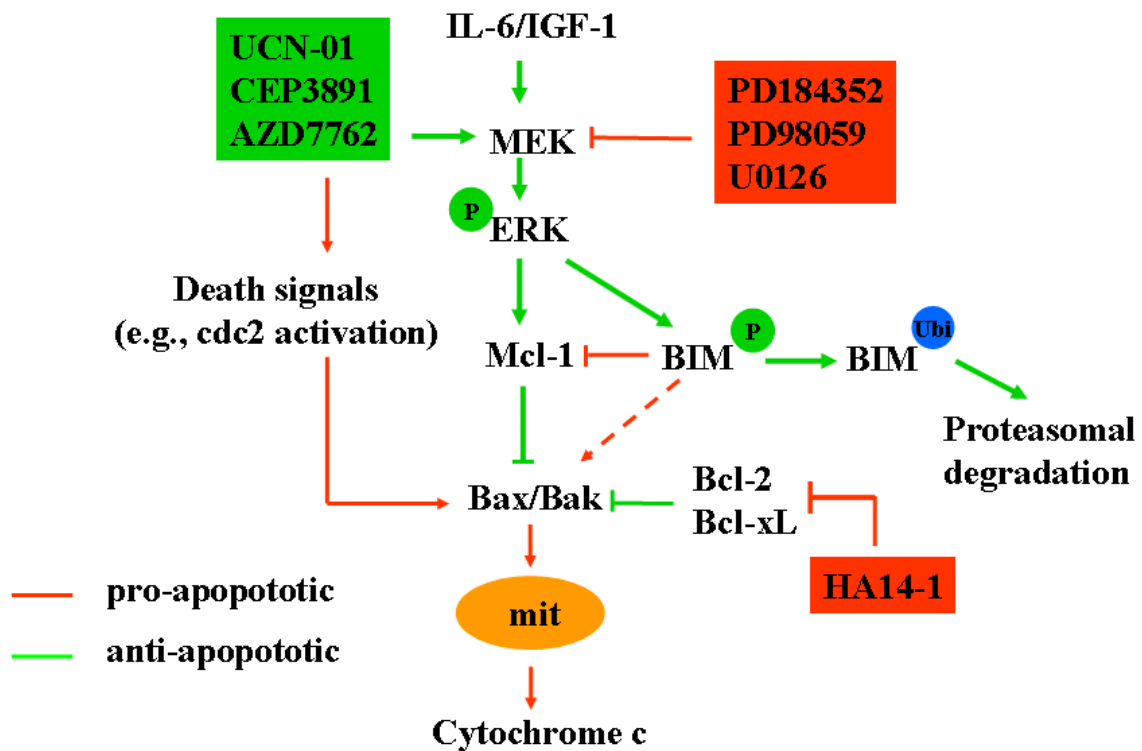

Figure 14. Displayed is a proposed model for the interactions between key apoptotic proteins and our applied drug treatments, the Chk1 inhibitors (UCN-01, CEP3891, AZD7762), the MEK1/2 inhibitors (PD184352, PD98059, U0126), and the small molecule Bcl-2 inhibitor (HA14-1). ERK1/2 activation by Chk1 inhibitors plays a cytoprotective role through mediating Bim phosphorylation and subsequent degradation. Remarkably, co-administration of MEK1/2 inhibitors blocks Chk1 inhibitor-induced ERK1/2 activation and Bim phosphorylation/degradation, leading to an increase in the amount of Bim associated with Bcl-2 and Bcl-xL. This disables the anti-apoptotic function of Bcl-2 and Bcl-xL. In MM cells over-expressing Bcl-2 anti-apoptotic proteins, HA14-1 acts to block the anti-apoptotic function of Bcl-2, thereby releasing Bcl-2 interference of Bax/Bak interaction and downstream intrinsic apoptotic events. These events produced by HA14-1 re-sensitize MM cells to the MEK1/2/Chk1 inhibitor regimen.

First, we observe a greater extent of cell death and mitochondrial outer membrane permeabilization in cells treated with the PD184352/CEP3891/HA14-1 regimen compared with the PD184352/CEP3891 regimen in parental U266 cells. These results were also obtained in two different MM cell lines, RPMI8226, and H929. Furthermore, we found that the increase of cell death and mitochondrial outer membrane permeabilization in Bcl-2 over-expressing cells treated PD184352/CEP3891/HA14-1,

compared with the PD184352/CEP3891 regimen, is significantly more profound in the cells with ectopic expression of Bcl-2 versus their parental cells. These findings indicate that Bcl-2 plays an important role in prevention of MM cells from apoptosis induced by the combination strategy of MEK1/2/Chk1 inhibitors.

Second, Western blot data suggests that the co-administration of HA14-1 with the PD184352/CEP3891 regimen induces a slightly increased cleavage of caspase-9, caspase-3, and PARP in U266 parental cells, compared with treatment with the PD184352/CEP3891 regimen. This phenomenon was also observed in two other MM cell lines: H929 and RPMI8226 (data not shown). In marked contrast, ectopic over-expression of Bcl-2 largely prevents cleavage of caspase-9, caspase-3, and PARP induced by the PD184352/CEP3891 regimen, exposure to PD184352/CEP3891/HA14-1 results in a significant increase in activation of this caspase cascade in the Bcl-2 over-expressed MM cells. In conjunction, re-sensitization of Bcl-2 over-expressing MM cells to the PD184352/CEP3891 regimen by HA14-1 is related to interruption of Bcl-2 anti-apoptotic function, and thus restoration, of apoptotic signaling pathway to be activated by the novel strategy combining MEK1/2 inhibitors with Chk1 inhibitors.

Third, upon results of Western blot analysis, there is no significant change in the phosphorylation/degradation state of Bim_{EL} in both parental and Bcl-2 over-expressing MM cells treated with PD184352/CEP3891/HA14-1 compared with cells treated with PD184352/CEP3891. Therefore, HA14-1 acts to overcome the resistance caused by ectopic expression of Bcl-2, which is unlikely through interference with ERK-mediated Bim_{EL} phosphorylation and degradation. Since Bcl-2 binds tightly and sequesters pro-apoptotic Bcl-2 family proteins including Bim_{EL}, it is assumed that ectopic over-

expressed Bcl-2 is capable of binding to and disabling more Bim_{EL} molecules. This may explain why exposure of Bcl-2 over-expressing cells to the PD184352/CEP3891 regimen only induces a limited degree of apoptosis while this regimen induces a marked Bim_{EL} accumulation almost equally in the parental versus Bcl-2 over-expressing MM cells.

These results suggest that ectopic over-expressed Bcl-2 prevents MM cells from lethality due to the MEK1/2/Chk1 inhibitor strategy by increased binding and sequestration of up-regulated Bim_{EL}. Therefore, the approach using a Bcl-2 antagonist like HA14-1 in conjunction with the PD184352/CEP3891 regimen significantly induces apoptosis of the MM cells with over-expression of Bcl-2. Since HA14-1 binds to the surface pocket of Bcl-2, where it also binds to the BH3-only protein Bim_{EL}, we presume that administration of HA14-1 may release Bim_{EL} from association with Bcl-2, rendering Bim_{EL} in its active/dephosphorylated form to activate Bax/Bak and induce MOMP, restoring sensitivity of MM cells with over-expression of Bcl-2 to the MEK1/2/Chk1 combination strategy.

Although HA14-1 cannot be used in clinical evaluation, several Bcl-2 antagonists (e.g., ABT737, ABT263, and GX15-070/Obatoclox) are developed and currently under clinical evaluation. The findings in the present work demonstrate the functional role of Bcl-2 in prevention of MM cells from lethality of the new strategy combining MEK1/2 and Chk1 inhibitors. They also may help to re-formulate this novel treatment for multiple myeloma patients that exhibit resistance or no response to the MEK1/2/Chk1 inhibitor regimen, particularly because of over-expression of Bcl-2. Several mechanistic issues remain to be further addressed or validated, such as whether Bcl-2 antagonists like HA14-1, do directly target at Bcl-2 and disable its ability to bind to and sequester pro-

apoptotic proteins, particularly Bim_{EL}. The strategy combining clinically relevant MEK1/2 inhibitors, Chk1 inhibitors, and Bcl-2 antagonists warrant further investigation, particularly in multiple myeloma cells with over-expression of Bcl-2.

LIST OF REFERENCES

1. Kroemer G, Galluzzi L, Vandenabeele P, Abrams J, Alnemri ES, Baehrecke EH, Blagosklonny MV, El-Deiry WS, Golstein P, Green DR, Hengartner M, Knight RA, Kumar S, Lipton SA, Malorni W, Nuñez G, Peter ME, Tschopp J, Yuan J, Piacentini M, Zhivotovsky B, Melino G. Classification of cell death: recommendations of the nomenclature committee on cell death 2009. *Cell Death and Differentiation*. 2009;16:3-11.
2. Hengartner MO. The biochemistry of apoptosis. *Nature*. 2000;407:770-776.
3. Fluda S, Debatin KM. Extrinsic versus intrinsic apoptosis pathways in anticancer chemotherapy. *Oncogene*. 2006;25:4798-4811
4. Brunelle JK, Letai A. Control of mitochondrial apoptosis by the Bcl-2 family. *Journal of Cell Science*. 2009;122:437-441.
5. Hengartner MO, Horvitz HR. *C. elegans* cell survival gene *ccd-9* encodes a functional homolog of the mammalian proto-oncogene *bcl-2*. *Cell*. 1994;76:665-676.
6. Damiano JS, Cress AE, Hazlehurst LA, Shtil AA, Dalton WS. Cell adhesion mediated drug resistance (CAM-DR): role of integrins and resistance to apoptosis in human myeloma cell lines. *Blood*. 1999;93:1658-1667.
7. Häcker G, Suttner K, Harada H, Kirschnek S. TLR-dependent Bim phosphorylation in macrophages is mediated by ERK and is connected to proteasomal degradation of the protein. *International Immunology*. 2006;18(12):1749-1757.
8. Pei XY, Dai Y, Tenorio S, Lu J, Harada H, Dent P, Grant S. MEK1/2 inhibitors potentiate UCN-01 lethality in human multiple myeloma cells through a Bim-dependent mechanism. *Blood*. 2007;110:2092-2101
9. O'Reilly LA, Cullen L, Visvader J, et al. The proapoptotic BH3-only protein bim is expressed in hematopoietic, epithelial, neuronal, and germ cells. *American Journal of Pathology*. 2000;157:449-461.
10. Puthalakath H, Strasser A. Keeping killers on a tight leash: transcriptional and post-translational control of the pro-apoptotic activity of BH3-only proteins. *Cell Death and Differentiation*. 2002;9:505-512.
11. Ley R, Ewings KE, Hadfield K, Cook SJ. Regulatory phosphorylation of Bim: sorting out the ERK from the JNK. *Cell Death and Differentiation*. 2005;12:1008-1014.
12. Lu J, Quearry B, Harada H. p38-MAP kinase activation followed by BIM induction is essential for glucocorticoid-induced apoptosis in lymphoblastic leukemia cells. *FEBS Letters*. 2006;12:580(14):3539-3544.

13. Damiano JS, Cress AE, Hazlehurst LA, Shtil AA, Dalton WS. Cell adhesion mediated drug resistance (CAM-DR): role of integrins and resistance to apoptosis in human myeloma cell lines. *Blood*. 1999;93:1658-1667.
14. O'Reilly LA, Cullen L, Visvader J, et al. The proapoptotic BH3-only protein Bim is expressed in hematopoietic, epithelial, neuronal, and germ cells. *American Journal of Pathology*. 2000;157:449-461.
15. Puthalakath H, Strasser A. Keeping killers on a tight leash: transcriptional and post-translational control of the pro-apoptotic activity of BH3-only proteins. *Cell Death and Differentiation*. 2002;9:505-512.
16. Akinaga S, Gomi K, Morimoto M, Tamaoki T, Okabe M. Antitumor activity of UCN-01, a selective inhibitor of protein kinase C, in murine and human tumor models. *Cancer Research*. 1991;51:4888-4892.
17. Chen X, Lowe M, Keyomarsi K. UCN-01-mediated G1 arrest in normal but not tumor breast cells is pRb dependent and p53-independent. *Oncogene*. 1999;41:5691-5702.
18. Graves PR, Yu L, Schwarz JK. The Chk1 protein kinase and the Cdc25C regulatory pathways are targets of the anticancer agent UCN-01. *The Journal of Biological Chemistry* 2000;275:5600-5605.
19. Wang Q, Worland PJ, Clark JL, Carlson BA, Sausville EA. Apoptosis in 7-hydroxystaurosporinetreated T lymphoblasts correlates with activation of cyclin-dependent kinases 1 and 2. *Cell Growth and Differentiation*. 1995;6:927-936.
20. Dai Y, Landowski TH, Rosen ST, Dent P, Grant S. Combined treatment with the checkpoint abrogator UCN-01 and MEK1/2 inhibitors potently induces apoptosis in drug-sensitive and resistant myeloma cells through an IL-6-independent mechanism. *Blood*. 2002;100:3333-3343.
21. Dai Y, Yu C, Singh V, et al. Pharmacological inhibitors of the mitogen-activated protein kinase (MAPK) kinase/MAPK cascade interact synergistically with UCN-01 to induce mitochondrial dysfunction and apoptosis in human leukemia cells. *Cancer Research*. 2001;61:5106-5115.
22. Karakas T, Maurer U, Weidmann E, Miething CC, Hoelzer D, Bergmann L. High expression of bcl-2 mRNA as a determinant of poor prognosis in acute myeloid leukemia. *Annals of Oncology*. 1998;9:129-130.

23. Cheng EH, Wei MC, Weiler S, et al. Bcl-2, Bcl-xL sequester BH3 domain-only molecules preventing Bax- and Bak-mediated mitochondrial apoptosis. *Molecular Cell*. 2001;8:705-711.
24. Pei XY, Dai Y, Grant S. The small-molecule Bcl-2 inhibitor HA14-1 interacts synergistically with flavopiridol to induce mitochondrial injury and apoptosis in human myeloma cells through a free radical-dependent and Jun NH2-terminal kinase-dependent mechanism. *Molecular Cancer Therapeutics*. 2004;3(12):1513-1524
25. Dai Y, Dent P, Grant S. Tumor necrosis factor-related apoptosis-inducing ligand (TRAIL) promotes mitochondrial dysfunction and apoptosis induced by 7-hydroxystaurosporine and mitogen-activated protein kinase kinase inhibitors in human leukemia cells that ectopically express Bcl-2 and Bcl-xL. *Molecular Pharmacology*. 2003;64(6):1402-1409.
26. Pei XY, Li W, Dai Y, Dent P, Grant S. Dissecting the roles of checkpoint kinase 1/CDC2 and mitogen-activated protein kinase kinase 1/2/extracellular signal-regulated kinase 1/2 in relation to 7-hydroxystaurosporine-induced apoptosis in human multiple myeloma cells. *Molecular Pharmacology*. 2006;70:1965-1973.
27. Bunch RT, Eastman A. Enhancement of cisplatin-induced cytotoxicity by 7-hydroxystaurosporine (UCN-01), a new G2-checkpoint inhibitor. *Clinical Cancer Research*. 1996;2:791-797.
28. Akiyama T, Sugiyama K, Shimizu M, Tamaoki T, Akinaga S. G1-checkpoint function including a cyclin-dependent kinase 2 regulatory pathway as potential determinant of 7-hydroxystaurosporine (UCN-01)- induced apoptosis and G1-phase accumulation. *Japanese Journal of Cancer Research*. 1999;90:1364-1372
29. Wang JL, Liu D, Zhang ZJ, Shan S, Han X, Srinivasula SM, Croce CM, Alnemri ES, Huang Z. *PNAS*. 2000;20;97(13):7124-7129.

VITA

Leena Eileen Youssefian was born on September 29, 1984 in Baltimore, Maryland. Leena received a Bachelors of Science in Biological Sciences from the University of California at Irvine in Irvine, California in June of 2006, after which she entered graduate school at Virginia Commonwealth University in Richmond, Virginia. Leena received a Masters of Science in Biochemistry in May 2009.